

Varenummer: 20992V40M12

Beskrivelse: E+G Gevind indsats - GN 992-V40-M12

Mål

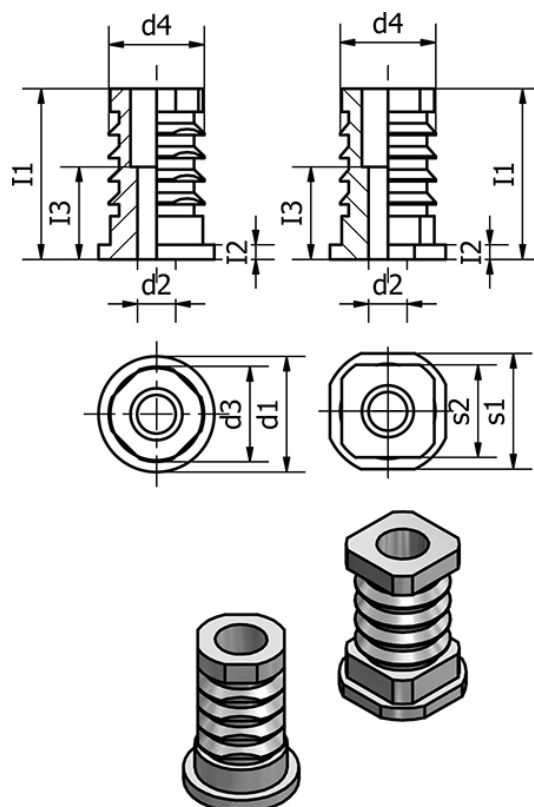

d1 =	s2 = 34
d2 = 12	Vægt (g) = 88
d3 =	
d4 = 34.5	
I1 = 41.5	
I2 = 2.5	
I3 = 24	
s1 = V40	